

# Tribal Manual of Approved Erosion Control and Storm Water Management Practices

## **Part II:** Common Erosion, Sediment and Storm Water Control Best Management Practices

Prepared by  
The Shakopee Sioux Community Land Department

March 15, 2003

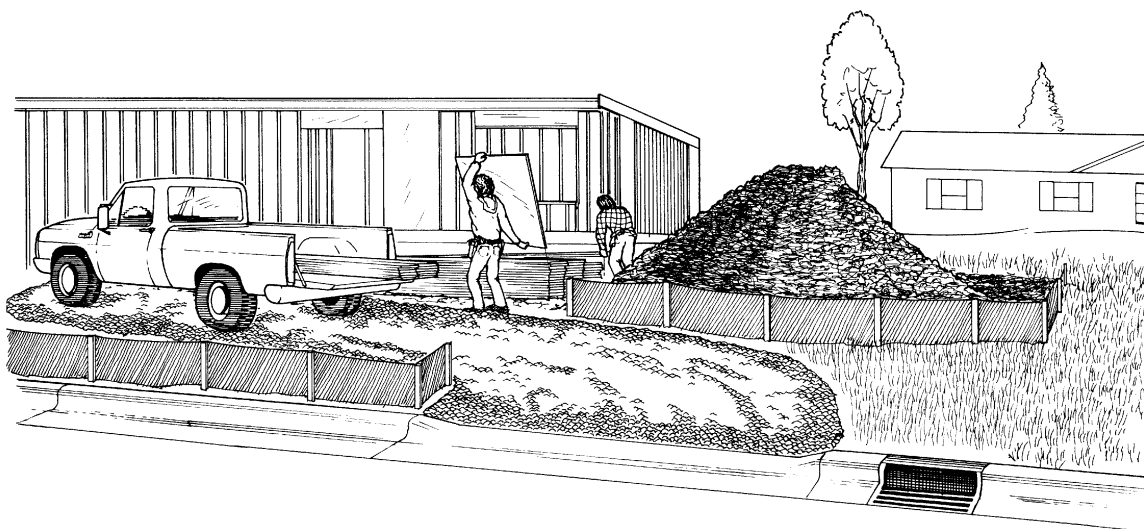

# CONTENTS

Introduction.....	1-1
1 Pollution Prevention BMPs .....	1-1
1.1 Construction Practices .....	1-1
1.1.1 Grading .....	1-1
1.1.2 Sequencing.....	1-2
1.1.3 Surface roughening.....	1-2
1.1.4 Temporary gravel construction entrance/exit .....	1-3
1.1.5 Erosion control blankets and mats .....	1-4
1.1.6 straw rolls.....	1-6
1.1.7 Vegetative stabilization methods.....	1-7
1.1.8 Silt Fences.....	1-9
1.1.9 Inlet Protection.....	1-12
1.1.10 Check dams.....	1-15
1.1.11 Erosion-control blankets.....	1-17
1.2 Design Requirements for Stormwater Retention/Detention Ponds and Temporary Sediment Basins 1-19	
1.2.12 General Criteria.....	1-19
1.2.13 Specific Requirements: .....	1-21
1.2.14 Temporary sediment basin.....	1-22
1.2.15 Infiltration/infiltration areas (MPCA, 2003).....	1-24
1.2.16 Regional Ponds .....	1-25
1.2.17 Combination of Practices.....	1-25
1.2.18 Alternative method .....	1-25
1.3 Directed Flow Outlets .....	1-26
1.4 Trash Racks.....	1-26
1.5 Energy Dissipaters .....	1-27
1.6 Riprap and Filter Material.....	1-27
1.7 Impervious Surfaces .....	1-29
1.7.19 Street Design.....	1-29
1.7.20 Cul-de-Sac-Design.....	1-30
1.7.21 Driveway Design .....	1-31
1.7.22 Parking Lot Design .....	1-32
2 References.....	2-35

## FIGURES

Figure 1. Surface Roughening .....	1-3
Figure 2 Temporary Gravel Construction Entrance/Exit.....	1-4
Figure 3 Straw roll typical .....	1-7
Figure 4. Type B, C, and D inlet protection .....	1-13
Figure 5. Type A inlet protection.....	1-13
Figure 6. Rock check dam typical .....	1-16
Figure 7 Long term average pond performance based on wet basin surface area in relation to percent of drainage area (Pitt, 1998).....	1-20

Figure 8 Baffles and contours in a pond system (Schueler, 1992) ..... 1-21

Figure 9. Riprap nomograph for Minnesota. .... 1-27

Figure 11. Street layout comparison (Source - Prince George's County, 2000 (adapted from ULI, 1980). 1-29

Figure 12 Street width alternatives (Source: Valley Branch Watershed District, 2000)..... 1-30

Figure 13. Cul-De-Sac Design..... 1-31

Figure 14 Alternative parking lot design (Source: Robert W. Droll, ASLA, in Wells 1994.) ..... 1-33

**TABLES**

Table 1. Silt fence specification (MnDOT, 2000) ..... 1-10

Table 2 Spacing of 2 foot check dams based on ditch grade (MPCA, 2000)..... 1-16

Table 3 Fabric categories (MPCA, 2000)..... 1-17

Table 4 Wet pond surface area required as a percent of drainage area, for a given land use goal of 90% sediment removal (Pitt, 1998)..... 1-20

Table 5. Maximum permissible mean velocities recommended by Fortier and Scobey\* for straight, aged channels on small slopes (\*1926 Special Committee on Irrigation, ASCE). .... 1-26

Table 6 Site design parking ratio ..... 1-32

Table 7 Rainwater Gardens Plant List (Source: Fred Rozumalski, Barr Engineering) ..... 1-34

## INTRODUCTION

The methods described in Part II of the Tribal Manual of Approved Erosion Control and Storm Water Management Practices are those that are common and acceptable for use on Tribal lands. The intention behind the manual is not to impose these best management practices upon every construction site for every circumstance but rather to provide information on the common methods for controlling erosion, sediment and storm water. If alternative methods for controlling erosion, sediment and storm water become available provide them to the Shakopee Mdewakanton Sioux Community Land Department for review.

Part II of the manual is by no means exhaustive. In fact this manual contains only a limited number and just a portion of what may be found in the sources found below or in any of the references provided at the end of this manual. If guidance is desired regarding erosion, sediment or stormwater control several excellent references may be found at the SMSC Land Department Office.

This manual was designed by reviewing and incorporating the methods from the following sources:

- ✓ McCullah, John. CPESC. 1994. *Erosion Draw: Erosion and Sediment Control Manual for Computer Aided Drafting*. Salix Applied EarthCare. Redding, CA.
- ✓ Minnesota Metropolitan Council Environmental Services; Barr Engineering Company, 2001. *Minnesota Urban Small Sites BMP Manual – Stormwater Best Management Practices for Cold Climates*.
- ✓ Minnesota Pollution Control Agency. 2000. *Protecting Water Quality in Urban Areas: Best Management Practices for Dealing with Storm Water Runoff from Urban, Suburban and Developing Areas of Minnesota*. St. Paul
- ✓ United States Environmental Protection Agency. 1992. *Developing Pollution Prevention Plans and Best Management Practices*. Office of Water, Washington, D.C.

# 1 POLLUTION PREVENTION BMPS

## 1.1 Construction Practices

### 1.1.1 Grading

#### 1.1.1.1 Description

Land grading is reshaping the ground surface to planned grades as determined by engineering survey evaluation and layout.

The purpose of grading is to provide more suitable topography for buildings, facilities and other land users; to control surface runoff; and to minimize soil erosion and sedimentation both during and after construction.

#### 1.1.1.2 Design

Base the grading plan upon adequate surveys and soil investigations. In the plan, show disturbed areas, cuts, fills, and finished elevation of the surface to be graded. Include in the Erosion and Sediment Control Plan all practices necessary for controlling erosion on the graded site and minimizing sedimentation downstream.

#### 1.1.1.3 Grading practices

In the Erosion and Sediment Control Plan, make provisions to intercept and conduct all surface runoff to stable watercourses and minimize erosion on newly graded slopes. Use slope breaks, such as diversion or benches, as appropriate to reduce the length of cut-and-fill slopes to limit sheet and rill erosion and prevent gullying.

- ✓ Provide stable channels and floodways to convey all runoff from the developed area to an adequate outlet without causing increased erosion or off-site sedimentation.
- ✓ Stabilize all graded areas with vegetation, mulch, wood chips, crushed stone, riprap or other ground cover as soon as grading is completed or work is interrupted for 14 working days or more.
- ✓ Use mulch, or other temporary measures, to stabilize areas temporarily where final grading must be delayed.
- ✓ The finished cut-and-fill slopes, which are to be vegetated with grass and legumes, should not be steeper than 2:1.
- ✓ Slopes that will be mowed should not be steeper than 3:1
- ✓ Slopes in excess of 2:1 may warrant mechanically stabilized earth walls, reinforced soil slopes or retaining walls.
- ✓ Finish grade slopes vertically so that machine tracks act as check dams instead of allowing rills to develop.
- ✓ Do not place cut or fill close to property lines without adequately protecting adjoining property from erosion, sedimentation, slippage, subsidence or other damages, especially at the toe of the slope.
- ✓ Provide subsurface drainage to intercept seepage in areas with high water tables that would affect slope stability or bearing strength or create undesirable wetness.
- ✓ Do not place fill next to a channel bank, where it can create bank failure or result in deposition of sediment.
- ✓ Use 4:1 slopes within 100 yards of waterbody edge where possible.

## 1.1.2 Sequencing

### 1.1.2.1 Description

A construction sequence schedule is a specified work schedule that coordinates the timing of land-disturbing activities and the installation of erosion protection and sediment control measures.

### 1.1.2.2 Design Considerations:

**Project design considerations:** Design project to integrate into existing land contours. Significant regrading of a site will require more costly erosion and sedimentation control measures and may require installation of on-site drainage and sediment control facilities.

**Incorporate existing natural areas:** Inventory and evaluate the existing site terrain and vegetation. Disturbance of highly erosive natural areas (e.g., steep, unstable slope areas and watercourses) should be minimized.

**Avoid rainy periods:** Schedule major grading operations during dry months. Allow enough time before rainfall begins to stabilize the soil with vegetation or physical means or to install temporary sediment trapping devices.

**Practice erosion and sediment control year round:** Erosion may be caused during dry seasons by "freak" rainfall, wind and vehicle tracking. Therefore, keep the site stabilized year-round, and maintain wet season sediment trapping devices.

**Apply perimeter control practices:** Protect the disturbed areas from off-site runoff and prevent sedimentation damage to areas below the development site by applying perimeter control devices.

**Minimize soil exposed at one time:** Schedule projects to disturb only small portions of the site at any one time. Complete grading as soon as possible. Immediately stabilize the disturbed portion before grading the next portion. Practice staged seeding in order to revegetate cut and fill slopes as the work progresses.

**Trenching:** Close and stabilize open trenches as soon as possible. Sequence trenching projects so that most open portions of the trench are closed before new trenching is begun.

## 1.1.3 Surface roughening

### 1.1.3.1 Construction Specifications:

#### *1.1.3.1.1 Cut Slope Roughening:*

- ✓ Stair-step grade or groove the cut slopes that are steeper than 3:1.
- ✓ Use stair-step grading on any erodible material soft enough to be ripped with a bulldozer. Slopes consisting of soft rock with some subsoil are particularly suited to stair-step grading.
- ✓ Make the vertical cut distance less than the horizontal distance, and slightly slope the horizontal position of the "step" in toward the vertical wall.
- ✓ Do not make individual vertical cuts more than 2 feet (0.6 m) high in soft materials or more than 3 feet (0.9 m) high in rocky materials.
- ✓ Groove the slope using machinery to create a series of ridges and depressions that run across the slope, on the contour.

#### *1.1.3.1.2 Fill Slope Roughening:*

- ✓ Place fill slopes with a gradient steeper than 3:1 in lifts not to exceed 8 inches (0.2 m), and make sure each lift is properly compacted.
- ✓ Ensure that the face of the slope consists of loose, uncompacted fill 4-6 inches (0.1-0.2 m) deep.

- ✓ Use grooving or tracking to roughen the face of the slopes, if necessary.
- ✓ Apply seed, fertilizer and straw mulch then track or punch in the mulch with the bulldozer.
- ✓ Do not blade or scrape the final slope face.

**1.1.3.1.3 Cuts, Fills, and Graded Areas:**

- ✓ Roughen these areas to shallow grooves by normal tilling, disking, harrowing, or use a cultipacker-seeder. Make the final pass of any such tillage on the contour.
- ✓ Make grooves formed by such implements close together (less than 10 inches (0.3 m)), and not less than 1 inch (25.4 mm) deep.
- ✓ Excessive roughness is undesirable where mowing is planned.

**1.1.3.1.4 Roughening With Tracked Machinery:**

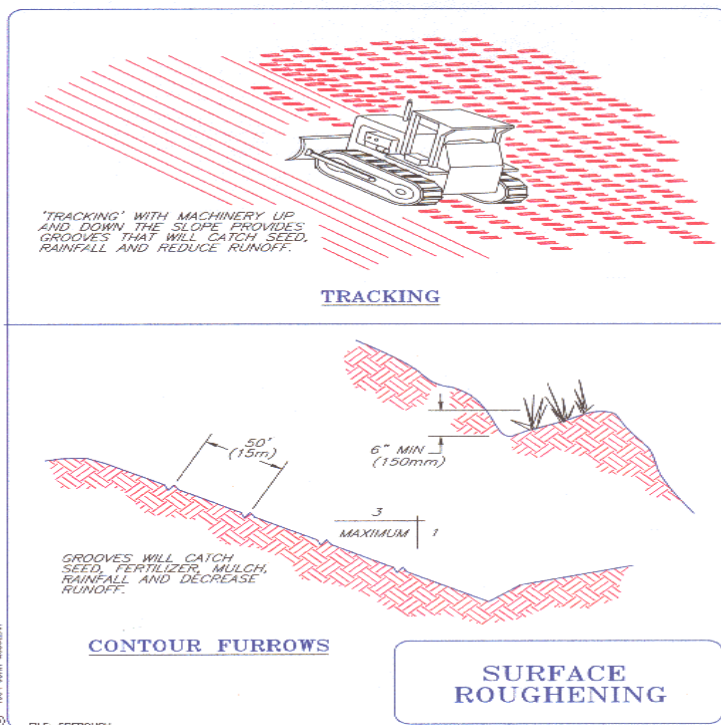

**Figure 1. Surface Roughening**

- ✓ Operate tracked machinery up and down the slope to leave horizontal depressions in the soil. Do not back-blade during the final grading operation.
- ✓ Immediately seed and mulch roughened areas to obtain optimum seed germination and growth.

**1.1.3.1.5 Inspection and Maintenance**

Periodically check the seeded slopes for rills and washes. Fill these areas slightly above the original grade, then reseed and mulch as soon as possible.

**1.1.4 Temporary gravel construction entrance/exit**

**1.1.4.1 Construction Specifications:**

- on the plans, and smooth it.
- ✓ The thickness of the pad shall not be less than 6 inches (0.2 m). Use geotextile fabrics, if necessary, to improve stability of the foundation in locations subject to seepage or high water table.
- ✓ The width of the pad shall not be less than the full width of all points of ingress or egress and in any case shall not be less than 12 feet (3.6 m) wide.
- ✓ The length of the pad shall be as required, but not less than 50 feet (15.2 m).
- ✓ Locate construction entrances and exits to limit sediment leaving the site and to provide for maximum utility by all construction vehicles. Avoid entrances that have steep grades and entrances at curves in public roads.

- ✓ The aggregate size for construction of the pad shall be 1-3 inch (51-76 mm) stone. Place the gravel to the specific grade and dimensions shown

- ✓ The entrance shall be maintained in a condition that will prevent tracking or flowing of sediment onto public rights-of-way. This may require periodic top dressing with additional stone as conditions demand, and repair and/or maintenance of any measures used to trap sediment.

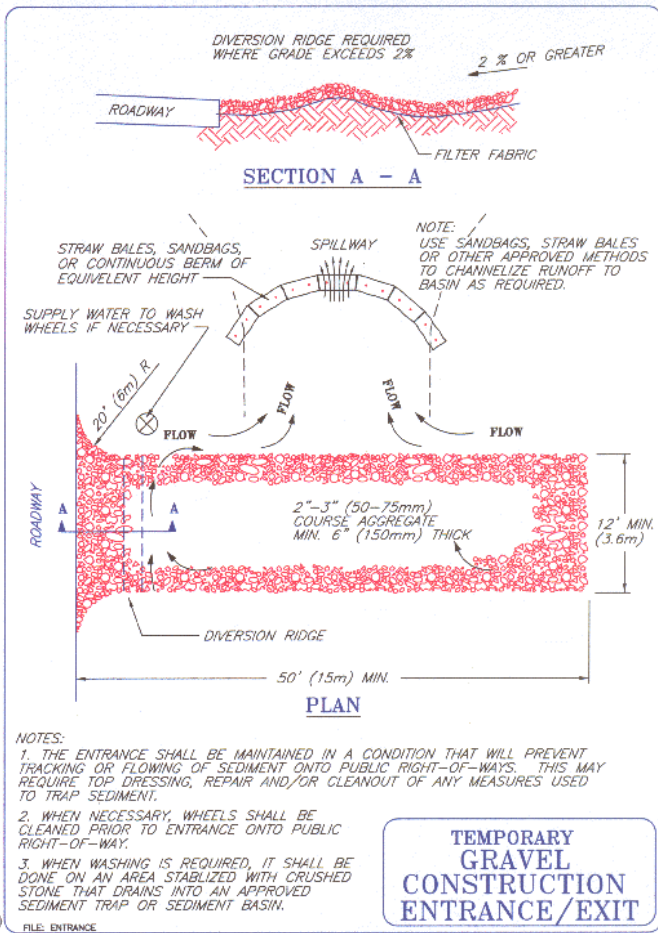

- ✓ All sediment spilled, dropped, washed or tracked onto public rights-of-way shall be removed immediately.
- ✓ Provide drainage to carry water to a sediment trap or other suitable outlet.
- ✓ When necessary, wheels shall be cleaned to remove sediment prior to entrance onto public rights-of-way. When washing is required, it shall be done on an area stabilized with crushed stone that drains into an approved sediment trap or sediment basin.
- ✓ All sediment shall be prevented from entering any storm drain, ditch or watercourse through use of sand bags, gravel, silt fence, straw rolls, or other approved methods.

#### 1.1.4.1.1 Inspections and Maintenance

- ✓ Maintain the gravel pad in a condition to prevent mud or sediment from leaving the construction site.
- ✓ Replace gravel material when surface voids are visible.
- ✓ After each ¼ inch rainfall inspect any structure used to trap sediment and clean it out as necessary.

**Figure 2 Temporary Gravel Construction Entrance/Exit**

- ✓ Immediately remove all objectionable materials spilled, washed, or tracked onto public roadways. Remove all sediment deposited on paved roadways within 24 hours.

### 1.1.5 Erosion control blankets and mats

#### 1.1.5.1 Purpose:

Erosion control blankets are used to temporarily or permanently stabilize and protect disturbed soil from raindrop impact and surface erosion, to increase infiltration, decrease compaction and soil crusting, and to conserve soil moisture.

#### 1.1.5.2 Construction Specifications:

##### 1.1.5.2.1 Site Preparation:

- ✓ Proper site preparation is essential to ensure complete contact of the protection matting with the soil.



- ✓ Grade and shape area of installation.
- ✓ Remove all rocks, clods, and vegetative or other obstructions so that the installed blankets, or mats will have direct contact with the soil.
- ✓ Prepare seedbed by loosening 2-3 inches (50.8-76.2 mm) of topsoil above final grade.
- ✓ Incorporate soil amendments if deemed necessary after a soil test.

#### *1.1.5.2.2 Seeding:*

- ✓ Seed area before blanket installation for erosion control and re-vegetation. Seeding after mat installation is often specified for turf reinforcement application. When seeding prior to blanket installation, all check slots and other areas disturbed during installation must be reseeded.
- ✓ Where soil filling is specified, seed the matting and the entire disturbed area after installation and prior to filling the mat with soil.

#### *1.1.5.2.3 Anchoring:*

U-shaped wire staples, metal geotextile stake pins, or triangular wooden stakes can be used to anchor mats to the ground surface. Wire staples should be a minimum of 11 gauge. Metal stake pins should be 3/16 inch (4.8 mm) diameter steel with a 1 1/2 inch (38.1 mm) steel washer at the head of the pin. Wire staples and metal stakes should be driven flush to the soil surface. All anchors should be 6-8 inches (0.2-0.5 m) long and have sufficient ground penetration to resist pullout. Longer anchors may be required for loose soils.

#### *1.1.5.2.4 Installation on Slopes:*

- ✓ Begin at the top of the slope and anchor its blanket in a 6 inch (0.2 m) deep x 6 inch (0.2 m) wide trench. Backfill trench and tamp earth firmly.
- ✓ Unroll blanket down slope in the direction of the water flow.
- ✓ The edges of adjacent parallel rolls must be overlapped 2-3 inches (51-76 mm) and be stapled every 3 feet (0.9 m).
- ✓ When blankets must be spliced, place blankets end over end (shingle style) with 6-inch (0.2 m) overlap. Staple through overlapped area, approximately 12 inches (0.3 m) apart.
- ✓ Lay blankets loosely and maintain direct contact with the soil - do not stretch.
- ✓ Blankets shall be stapled sufficiently to anchor blanket and maintain contact with the soil. Staples shall be placed down the center and staggered with the staples placed along the edges. Steep slopes, 1:1 to 2:1, require 2 staples per square yard. Moderate slopes, 2:1 to 3:1, require 1-2 staples per square yard (1 staple 3' o.c.). Gentle slopes require 1 staple per square yard.

#### *1.1.5.2.5 Installation in channels:*

- ✓ Dig initial anchor trench 12 inches (0.3 m) deep and 6 inches (0.2 m) wide across the channel at the lower end of the project area.
- ✓ Excavate intermittent check slots, 6 inches (0.2 m) deep and 6 inches (0.2 m) wide across the channel at 25-30 foot (7.6-9.1 m) intervals along the channel.
- ✓ Cut longitudinal channel anchor slots 4 inches (101 mm) deep and 4 inches (101 mm) wide along each side of the installation to bury edges of matting. Whenever possible extend matting 2-3 inches (51-76 mm) above the crest of channel side slopes.
- ✓ Beginning at the downstream end and in the center of the channel, place the initial end of the first roll in the anchor trench and secure with fastening devices at 1 foot (.3 m) intervals. **Note:** matting will initially be upside down in anchor trench.

- ✓ In the same manner, position adjacent rolls in anchor trench, overlapping the preceding roll a minimum of 3 inches (7.6 cm).
- ✓ Secure these initial ends of mats with anchors at 1 foot (0.3 m) intervals, backfill and compact soil.
- ✓ Unroll center strip of matting upstream. Stop at next check slot or terminal anchor trench.
- ✓ Unroll adjacent mats upstream in similar fashion, maintaining a 3 inch (76 mm) overlap.
- ✓ Fold and secure all rolls of matting snugly into all transverse check slots. Lay mat in the bottom of the slot then fold back against itself. Anchor through both layers of mat at 1 inch (25.4 mm) intervals, then backfill and compact soil. Continue rolling all mat widths upstream to the next check slot or terminal anchor trench.
- ✓ Seed and fill turf reinforcement matting with soil, if specified.

#### 1.1.5.2.6 Soil filling

If specified for turf reinforcement:

- ✓ After seeding, spread and lightly rake 1/2-3/4 inches (12.7-19.1 mm) of fine topsoil into the mat apertures to completely fill mat thickness. Use backside of rake or other flat implement.
- ✓ Spread topsoil using lightweight loader, backhoe, or other power equipment. Avoid sharp turns with equipment.
- ✓ Do not drive tracked or heavy equipment over mat.
- ✓ Avoid any traffic over matting if loose or wet soil conditions exist.
- ✓ Use shovels, rakes or brooms for fine grading and touch up.
- ✓ Smooth out soil filling, just exposing top netting of matrix.

#### 1.1.5.2.7 Inspection and maintenance

- ✓ All blanket and mats should be inspected periodically following installation.
- ✓ Inspect installation after each ¼ inch rainstorm to check for erosion and undermining. Any failure should be repaired immediately.
- ✓ If washout or breakage occurs, re-install the material after repairing the damage to the slope or drainageway.

### 1.1.6 straw rolls

#### 1.1.6.1 Construction Specifications



- ✓ Prepare the slope before the wattling procedure is started.
- ✓ Shallow gullies should be smoothed as work progresses.
- ✓ Dig small trenches across the slope on contour, to place rolls in. The trench should be deep enough to accommodate half the thickness of the roll. When the soil is loose and uncompacted, the trench should be deep enough to bury the roll 2/3 of its thickness because the ground will settle.
- ✓ It is critical that rolls are installed perpendicular to water movement, parallel to the slope contour.
- ✓ Start building trenches and install rolls from the bottom of the slope and work up.
- ✓ Construct trenches at contour intervals of 3-12 feet (0.9-3.7 m) apart depending on steepness of slope. The steeper the slope, the closer together the trenches.

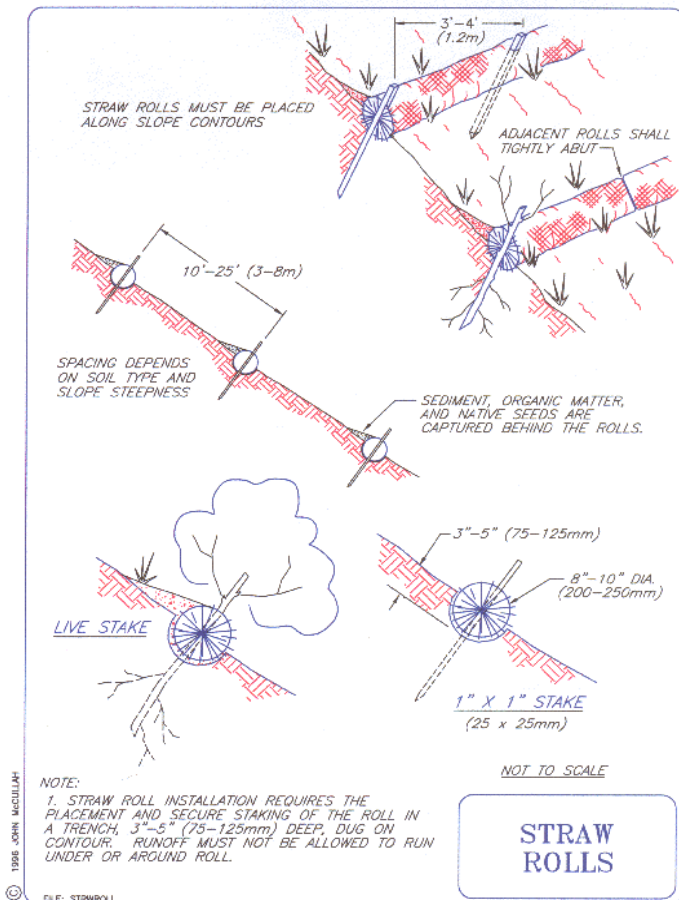

Figure 3 Straw roll typical

### 1.1.7 Vegetative stabilization methods

#### 1.1.7.1 Description

Vegetative stabilization is the process of establishing vegetation on a construction site to prevent erosion. The first step in erosion control on construction sites is to limit vegetation clearing. The next step is to reestablish vegetation as quickly as possible on any exposed soil. For example, cut and fill slopes, soil stockpiles, dikes, denuded landscapes, and vegetation waterways. Annual grasses such as oats, annual rye and winter wheat are recommended for use in Minnesota.

#### 1.1.7.2 Design

A choice must be made whether vegetation will be established by seeding or sodding.

##### 1.1.7.2.1 Seeding

- ✓ Selection of species for a specific site should be based on soils, moisture conditions, light levels, whether or not concentrated flows will occur, land use, and level of maintenance.
- ✓ Seeding has advantages including lower establishment costs, wide selection of seed mixes (both native and nonnative) and is easier to install on different sites.

- ✓ Lay the roll along the trenches fitting it snugly against the soil. Make sure no gaps exist between the soil and the straw wattle.
- ✓ Use a straight bar to drive holes through the wattle and into the soil for the willow or wooden stakes.
- ✓ Drive the stake through prepared hole into soil. Leave only 1 or 2 inches (25 or 51 mm) of stake exposed above roll.
- ✓ Install stakes at least every 4 feet (1.2 m) apart through the wattle. Additional stakes may be driven on the downslope side of the trenches on highly erosive or very steep slopes.

##### 1.1.6.1.1 Inspections and Maintenance

- ✓ Inspect the straw rolls and the slopes after significant storms. Make sure the rolls are in contact with the soil.
- ✓ Repair any rills or gullies promptly.
- ✓ Reseed or replant vegetation if necessary until the slope is stabilized.

- ✓ The use of seeding mixtures that includes native grass species should be considered for improving wildlife habitat and aesthetics.

### 1.1.7.3 Design

- ✓ Seed should be applied uniformly with a cyclone seed, drill or cultipacker seeder, or hydroseeder. When feasible, seed that has been broadcast shall be covered by raking or dragging and then lightly tamped into place using a roller or cultipacker. If hydroseeding is used, the seed and mulch must be applied in separate applications.

#### 1.1.7.3.1 *Sodding*

- ✓ Sodding has advantages including immediate erosion control, reduced chance of failure, few weed problems and shorter time interval until site can be used.
- ✓ Sodding can be used for final landscaping and in drainageways, where high velocities would prevent grass seed from establishing.

### 1.1.7.4 Implementation

Two options available for establishing vegetation are seeding and sodding. Regardless of which technique is used, some basic requirements need to be met to ensure good vegetative establishment.

- ✓ In hydroseeding, often used on larger areas, seeds are mixed with water and fertilizer where necessary, and a fiber mulch is sprayed onto the soil in a second separate layer.
- ✓ Temporary seeding should be applied on exposed soil where additional work (grading, etc.) is not scheduled for more than 14 days. Temporary seeding of annual grasses may be used for up to 12 months to temporarily stabilize exposed areas. Soil amendments may be needed to establish vegetation on some construction areas.
- ✓ Permanent seeding should be applied if the areas will be idle for more than a year.
- ✓ Structural erosion and sediment control practices such as diversions and sediment traps shall be installed and stabilized with temporary seeding prior to grading the rest of the construction site.
- ✓ Exposed soils should have temporary or permanent cover within the following time frames:
  - Steeper than 3:1, within 7 days.
  - All other soils within 14 days

*Note: While these requirements allow some time to establish protective cover the SMSC encourages immediate vegetative establishment between times when the soil is actively being worked. Often this requires the site to be seeded several times during a construction project.*

- ✓ The seedbed should be pulverized and loosened to ensure the success of establishing vegetation. However, temporary seeding should not be postponed if ideal seedbed preparation is not possible. Disturbed sites require seedbed preparation to loosen the soil surface for water infiltration and root penetration.
- ✓ Establishing nonnative planting sometimes requires a fertilizer application to initiate growth. Apply these nutrients according to soil test recommendations.
- ✓ With the exception of turfgrass, vegetation establishment shall consist of native weed-free plants and/or seed.

### 1.1.7.5 Maintenance

#### 1.1.7.5.1 *Seedings*

- ✓ Seeded areas must be kept consistently moist for the first three weeks after planting. If necessary, use mulch to retain soil moisture.
- ✓ Areas seeded in nonnative grasses should be mowed once or twice a year to prevent the establishment of woody plants.
- ✓ See Land Department for further guidance.

#### 1.1.7.5.2 Sod

- ✓ Turf sod should be kept evenly moist for the first three weeks after being put down.
- ✓ After establishment, turf sod need not be watered during dry periods. It can be left to dormant.

### 1.1.8 Silt Fences

#### 1.1.8.1 Description

A silt fence is a temporary barrier designed to retain sediment on the construction site. The fence retains sediment primarily by retarding flow and promoting deposition on the uphill side of the fence. Runoff is also filtered as it passes through the geotextile.

Silt fences are intended to intercept and detain small amounts of sediment from disturbed areas. They can also prevent sheet erosion by decreasing the velocity of runoff.

The use of silt fences as a sediment barrier is not recommended in areas of concentrated flow, such as ditches. In those cases, reinforced vegetated soil berms or silt dikes, straw wattles and excelsior logs, or rock check dams should be used.

#### 1.1.8.2 Limitations

- ✓ Not effective for concentrated flows
- ✓ Proper installation is critical for effective performance
- ✓ Frequent inspection and maintenance required

#### 1.1.8.3 General planning and siting

In operation, the fence generally becomes clogged with fine particles, which reduces the flow rate. This causes a pond to develop more quickly behind the fence. The designer should anticipate ponding and provide sufficient storage areas and overflow outlets to prevent flow from overtopping the fence. Since silt fences are not designed to withstand high standing water, locate them so that only shallow pools can form. Often a crescent shape will perform better than the traditional straight line.

Deposition occurs as the storage pool forms behind the fence. The designer can direct flows to specified deposition areas through appropriate positioning of the fence or by providing an excavated area behind the fence. Plan deposition areas at accessible point to facilitate cleanout and maintenance. Show deposition areas in the erosion and sedimentation control plan.

- ✓ Install silt fences on the contour (as opposed to up and down a hill) and construct so that flow cannot pass the ends.
- ✓ Ensure that the drainage area is no greater than ¼ acre per 100 feet of fence.
- ✓ Make the fence stable for the 10-year peak storm runoff.
- ✓ By design, ensure that the depth of impounded water does not exceed 2 feet at any point along the fence.

#### 1.1.8.4 Types

The following three types of silt fences are used for different circumstances. For details on each type of fence see (Table 1)

- ✓ *Heavy Duty.* Use at locations where extra strength is required, such as near water bodies; on areas with unstable wetland soils, steep slopes, highly erodible soils or high runoff; and on areas that are inaccessible to equipment.
- ✓ *Preassembled.* For light-duty application, to protect construction or to supplement the other types of silt fence. This type is installed with plow-type equipment with preattached stakes spread at 6-to 8-foot intervals.
- ✓ *Machine-Sliced Installation.* Appropriate for general use during site grading and to protect critical areas. Preferred for most sites due to the effective installation method.

	<b>Heavy Duty</b>		<b>Machine Sliced</b>	<b>Preassembled</b>
<b>Description</b>	Composite of mesh backing, posts, geotextile and fastners, assembled		Machine installed geotextile fastened to posts on site	Ready-to-install unit of geotextile attached to driveable posts
<b>Geotextile</b>				
Type	Woven		Woven monofilament*	Woven
Width	48 inches		36 inches	36 inches
Grab Tensile ASTM C4632 (machine direction)	100 lb. minimum		130 lb. minimum	100 lb. Minimum
Apparent Opening Size ASTM D4751	#20-70 sieve		#30-40 sieve	#20-70 sieve
UV Stability ASTM D4355 500 hours	70 percent minimum		70 percent minimum	70 percent minimum
Flow Rate ASTM D4491 gal./min./sq.ft.			100 gal./min./sq. ft.	
Top Fastening component	6-inch overlap, top of mesh backing		Selvaged edge	Sewn-in cord
<b>Net Backing</b>				
Material	Woven wire mesh	Plastic mesh		
Steel Wire Gauge	14 minimum			
Max. Mesh Opening	6 inches	2 inches		
<b>Rope for Ditch Check</b>				
Type			Polyethelyne	
Diameter			5/8-inch minimum	
<b>Posts</b>				
Material	Steel T-post		Steel T-post with welded plate	Wood
Minimum Size	1.26 lbs./in./ft.		1.26 lbs./in./ft	2 x 2 inch
* No substitution allowed, monofilament in both directions				

**Table 1. Silt fence specification (MnDOT, 2000)**

### 1.1.8.5 Design

#### 1.1.8.5.1 Basic Components

- ✓ *Geotextile* Should be uniform in texture and appearance and have no defects, flaws or tears that would affect its physical properties. It should contain sufficient ultraviolet (UV) ray inhibitor and stabilizers to provide a minimum two-year service life outdoors (See Table 1).
- ✓ *Wire mesh backing* is required with heavy duty silt fence. Use three vertically placed wire fasteners (“hog rings”) to fasten the geotextile woven wire fence material at a minimum spacing of 2 feet (See Table 1).
- ✓ *Steel posts* are used for heavy duty silt fence (maximum 8 feet apart) and machine-sliced installation (maximum 6 feet apart). Steel posts should be 1.25 lb./linear ft. with a minimum length of 5 feet. They should have projection to facilitate fastening the fabric. Standard metal T post with a welded plate for both installations.

Standard application may use wooden posts, 1.5-inch hardwood with a minimum length of 4 feet. They should have a sharpened end and should be set in the ground at least 1.5 feet deep. Each post should be spaced 4 to 8 feet apart, depending on the type, and securely fastened to the geotextile and net backing by ties or staples suitable for such purpose (Table 1).

### 1.1.8.6 Construction

#### 1.1.8.6.1 General Notes and Cautions

Silt fence should:

- ✓ Meet the requirements of MnDOT specifications 3886.
- ✓ Not be placed to control concentrated flow.
- ✓ Be put in sequence to extend the slope length allowable. Other methods must be used if the allowable distance is exceeded.
- ✓ Be tied into the slope to prevent erosion around the ends.
- ✓ Never be attached to rigid structures.
- ✓ Preferably have joints rapped together around the posts.
- ✓ Silt fences should not be designed to impound sediment or water more than 18 inches (0.5 m) high. Sediment shall be cleaned from behind the fence when it reaches 30% of the designed impoundment height (9 inches, or 0.2 m).
- ✓ Silt fences, regardless of the type of fabric, routinely plug up with sediment. Do not count on them to filter sediment.
- ✓ It is not recommended nor is it effective to use silt fence around drop inlets or in front of storm drain inlets because the fabric cannot pass the flows necessary to prevent flooding.

#### 1.1.8.6.2 Heavy Duty Silt Fence

- ✓ Metal posts should be spaced maximum of 8 feet apart.
- ✓ The geotextile should be attached to the upstream side of the post. The bottom edge of the geotextile should be buried at least 6 inches deep in a vertical slot or trench, with the soil pressed firmly against the embedded geotextile.
- ✓ When wire mesh is used, wire fasteners (hog rings) shall be fastened to the geotextile on the top of the mesh along the upper edge at a maximum spacing of 1 foot. A minimum of 3 metal U-shaped clips or wire shall fasten the wire mesh and two layers of geotextile to the metal posts.

- ✓ When plastic mesh is used, the mesh backing should be joined to the geotextile at the top with two rows of stitching. Geotextile should protrude below the bottom edge of the plastic mesh to allow embedment. A minimum of 3 metal U-shaped clips or wire shall fasten the plastic mesh and geotextiles to the metal posts.

#### 1.1.8.6.3 Machine-Sliced Silt Fence

- ✓ Posts should be set a maximum of 6 feet apart.
- ✓ A geotextile fabric should be inserted in a slit in the soil (6 to 12 inches deep). The slit should be created such that a horizontal chisel point, at the base of a soil-slicing blade, slightly disrupts soil upward as the blade slices through the soil. This upward disruption minimizes horizontal compaction and creates an optimal soil condition for mechanical compaction against the geotextile. The geotextile should be mechanically inserted directly behind the soil-slicing blade in a simultaneous operation, achieving consistent placement and depth. No turning over (plowing) of soil is required for the slicing method.

#### 1.1.8.6.4 Maintenance

- ✓ Inspect silt fences at least once a week and after each ¼” rainfall. Make any required repairs immediately. Repair scoured areas on the backside of the fence at this time to prevent future problems.
- ✓ Should the fabric of a silt fence collapse, tear, decompose or otherwise become ineffective, replace it within 24 hours.
- ✓ Remove silt fence deposits once they reach 30 percent the height of the fence to provide adequate storage volume for the next rain and to reduce pressure on the fence. Take care to avoid undermining the silt fence during cleanout.
- ✓ It may be easier and more effective to remove and replace the silt fence when removing silt deposits.
- ✓ Silt fences are to be removed upon stabilization of the contributing drainage area. Accumulated sediment may be spread to form a surface for turf or other vegetation establishment, or disposed of elsewhere. The area should be reshaped to permit natural drainage.

### 1.1.9 Inlet Protection

#### 1.1.9.1.1 Description

Storm drain inlet protection methods prevent sediment from entering storm drainage systems prior to permanent stabilization of the disturbed area. This can include a sediment filter or an excavated impounding area around a storm drain drop inlet or curb inlet or a geotextile barrier supported around or across a storm drain inlet.

#### 1.1.9.1.2 Design

This specification covers inlet protection for controlling sedimentation into and through storm sewer inlets. Inlet protection will be classified by type according to use by MnDOT standards (see details that follow). Type will be as indicated herein:

Type A: Inlet protection to be utilized around field inlets until permanent stabilization methods have been established. Inlet protection Type A may also be utilized on pavement inlets prior to installation of curb and gutter or pavement. This method is applicable where the inlet drains a relatively flat area (slopes of less than 3%) where sheet flow is typical. This method is not recommended for inlets receiving concentrated flows, such as in road ditches.



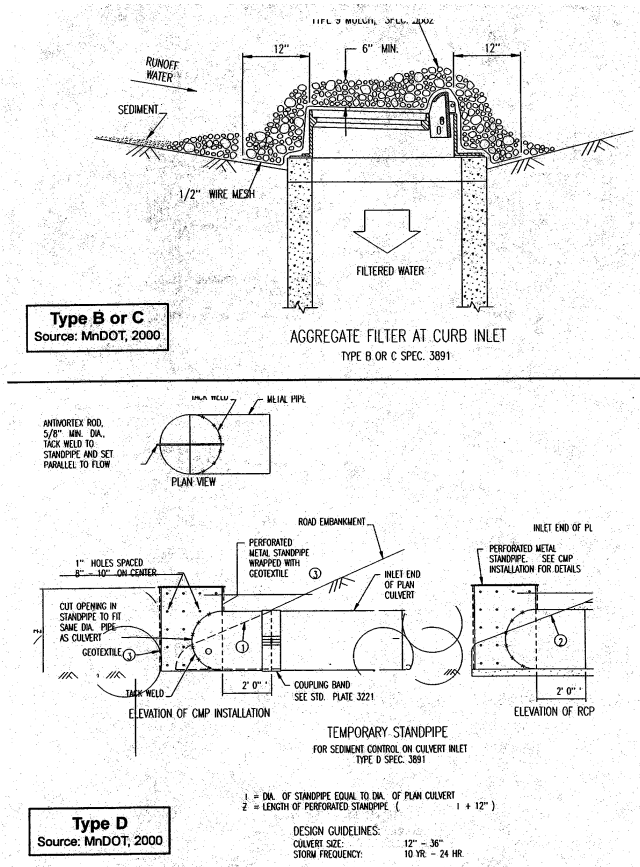

Figure 4. Type B, C, and D inlet protection

1.1.9.1.3 Sequencing

- ✓ Inlet protection should be placed immediately after the storm sewer inlets are installed.
- ✓ Inlet protection may need to be removed during certain phases of construction. As soon as practical, inlet protection should be replaced.
- ✓ The result that blocking storm drain inlets will have on the site's drainage must be considered. Long sloping streets or ditches designed with several inlets along their length may have significant amount of surface flow accumulate if inlet protection is needed.
- ✓ In low areas, a pond will form around inlets. Ponding is necessary for removing sediment from runoff and should be encouraged in conjunction with inlet protection.
- ✓ Erosion-control practices should be used upstream to

Type B: Inlet protection will be utilized on street inlets without curb heads. This method of inlet protection is applicable if heavy flows are expected and when an overflow capacity is needed to prevent excessive ponding around the structure.

Type C: Inlet protection will be utilized on street inlets with curb heads. This method of inlet protection is applicable if heavy flows are expected and when an overflow capacity is needed to prevent excessive ponding around the structure.

Type D: Inlet protection to be utilized at culvert inlets until permanent stabilization methods have been established.

Sediment Trap: Inlet protection for median drains that are not at the lowest point (see Temporary Sedimentation Basins/Traps BMP).

Inlet protection should only be used in locations where sediment can be removed and temporary ponding will not create a safety hazard or cause property damage. Various designs have been adapted for different conditions.

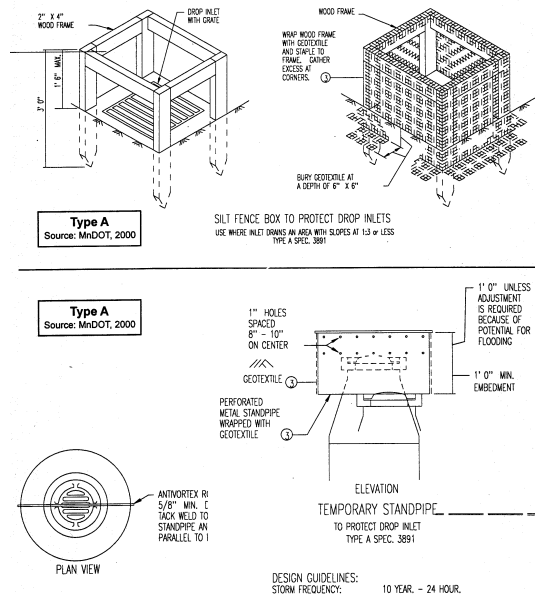

Figure 5. Type A inlet protection

limit sediment movement from disturbed areas to the inlets.

- ✓ The inlet protection should be left in place until the drainage area is stabilized with established vegetation or pavement.

### 1.1.9.2 Curb inlet protection

#### *1.1.9.2.1 Construction Specifications*

- ✓ Place the barriers on gently sloping streets where water can pond.
- ✓ The barriers must allow for overflow from a severe storm event. Slope runoff shall be allowed to flow over blocks and gravel and not be bypassed over the curb. A spillway shall be constructed with the sandbag structures to allow overflow.
- ✓ The sandbag should be of woven-type geotextile fabric since burlap bags deteriorate rapidly.
- ✓ The sandbags shall be filled with 3/4 inch (19 mm) drain rock or 1/4 inch (6 mm) pea gravel.
- ✓ The sandbags shall be placed in a curved row from the top of curb at least 3 feet (0.9 m) into the street. The row should be curved at the ends, pointing uphill.
- ✓ Several layers of bags should be overlapped and packed tightly.
- ✓ Leave a one-sandbag gap in the top row to act as a spillway.

#### *1.1.9.2.2 For Block and Gravel Type Barriers:*

- ✓ Place two concrete blocks on their sides perpendicular to the curb at either end of the inlet opening. These will serve as spacer blocks.
- ✓ Place concrete blocks on their sides across the front of the inlet and abutting the spacer blocks. The openings in the blocks should face outward, not upward.
- ✓ Cut a 2 by 4 inch (51 by 102 mm) stud the length of the curb inlet plus the width of the two spacer blocks. Place the stud through the outer hole of each spacer block to help keep the front blocks in place.
- ✓ Place wire mesh over the outside vertical face (open ends) of the concrete blocks to prevent stone from being washed through the blocks.
- ✓ Use chicken wire, hardware cloth with 1/2 inch (13 mm) openings, or filter fabric.
- ✓ Place 3/4 -1 1/3 inch (19-34 mm) gravel against the wire to the top of the barrier.

#### *1.1.9.2.3 Inspection and maintenance*

- ✓ Inspect and clean barrier during and after each significant storm and remove sediment from behind the sandbag structure after every storm.
- ✓ Any sediment and gravel shall be immediately removed from the traveled way of roads.
- ✓ The removed sediment shall be placed where it cannot enter a storm drain, stream, or be transported off site.
- ✓ If the gravel becomes clogged with sediment, it must be carefully removed from the inlet and either cleared or replaced.

### 1.1.9.3 Drop inlet sediment barrier

#### *1.1.9.3.1 Silt Fence Barrier:*

- ✓ Support posts for a silt fence must be steel fence posts or 2 by 4 inch (51 by 102 mm) wood, length 3 foot (0.9 m) minimum, spacing 3 foot (0.9 m) maximum, with a top frame support recommended.

- ✓ Excavate a trench 4 inches (101 mm) wide and 6 inches (0.2 m) deep and bury the bottom of the silt fence in the trench.
- ✓ Backfill the trench with gravel or soil. Compact the backfill well.
- ✓ The height of the silt fence shall be a 1.5 foot (0.5 m) maximum, measured from the top of the inlet.

*1.1.9.3.2 Gravel Doughnut:*

- ✓ Keep the stone slope toward the inlet at 3:1 or flatter or use concrete blocks to help prevent the stone from being washed into the drop inlet. A minimum 1 foot (0.3 m) wide level area set 4 inches (101 mm) below the drop inlet crest will add further protection against the entrance of material.
- ✓ Stone on the slope toward the inlet should be 3 inches (76 mm) or larger for stability, and 1 inch (25 mm) or smaller on the slope away from the inlet to control flow rate.
- ✓ Wire mesh with 2 inch (51 mm) openings may be placed over the drain grating, but must be inspected frequently to avoid blockage by trash. If concrete blocks are used the openings should be covered with wire screen or filter fabric.

*1.1.9.3.3 Inspection and Maintenance:*

- ✓ Inspect the barrier after each rain and promptly make repairs as needed.
- ✓ Sediment shall be removed after each significant storm (1 inch (25 mm) in 24 hours) to provide adequate storage volume for the next rain.
- ✓ The removed sediment shall be deposited in an area that will not contribute sediment off-site and can be permanently stabilized.
- ✓ For gravel filters: If the gravel becomes clogged with sediment it must be carefully removed from the inlet and either cleaned or replaced.

1.1.10 Check dams

1.1.10.1 Description

Check dams are generally used in concentrated-flow areas, such as ditches and swales. Check dams can either be permanent or temporary barriers to slow flow velocities and /or to filter concentrated flows. Ditch check dams tend to pond water. Under low-flow situations, water ponds behind the structure and seeps slowly through, infiltrates or evaporates. Under high-flow situations, water flows over and/or through the structure. Check dams **do not** include staked hay bales or silt fence placed in a concentrated flow area. In the case of waddles and fiber logs, many times these will become a permanent part of vegetation establishment.

1.1.10.2 Design

Rock check dams should consist of well-graded stone consisting of a mixture of rock sizes. For example: Class IV riprap with the percent less than the specified rock diameter.

- |                    |                  |
|--------------------|------------------|
| ✓ 100% < 24 inches | ✓ 50% < 9 inches |
| ✓ 75% < 15 inches  | ✓ 10% < 4 inches |

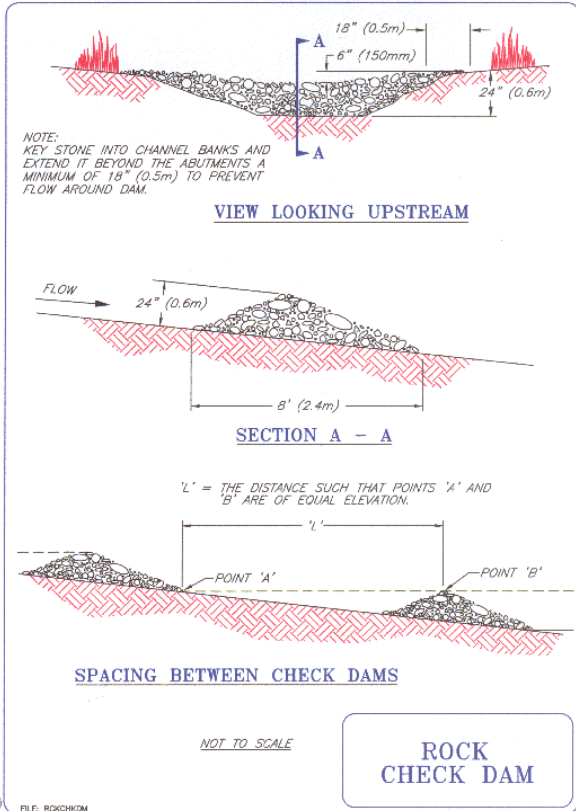

**Figure 6. Rock check dam typical**

Other options include 1.5-inch clean gravel and river rock. When riprap is provided on a project, the riprap can be temporarily used for rock checks, removed, and then reused for the permanent riprap installation. In a series of check dams, the top center of the downstream check dam should be at the bottom of the upstream check dam (See Figure 6).

The spacing can be calculated by multiplying the height of the check dam by the slope H:V or by dividing by the slope in %. The spacing given in Table 2 is based on a 2 foot-high check dam.

A triangular silt dike is a triangular-shaped foam block covered with geotextile fabric. When laid in the channel, it will form a check dam.

Straw waddles and excelsior logs are straw and wood-fiber cores wrapped with synthetic netting. They can be partially buried in a channel to create mini dams. They are available in many diameters to meet site requirements.

To increase the effectiveness of rock check dams, a shallow pool upstream of the check is recommended. The pool allows additional sediment storage.

Ditch grade (%)	Spacing (feet)
1	200
2	100
4	50
6	33
Above 6% ditch grade, you may need to flatten the slope	
8	25
10	20

**Table 2 Spacing of 2 foot check dams based on ditch grade (MPCA, 2000)**

### 1.1.10.3 Construction specifications

Install all structural check dams as recommended by the manufacturer. When stone dams are used, generally follow the following procedures:

1. Place stone to the lines and dimensions shown in the plan over a nonwoven geotextile fabric foundation.

2. Keep the center stone section at least 6 inches below natural ground level where the dam abuts the channel banks.
3. Extend stone at least 1.5 feet beyond the ditch banks (Figure 6) to keep overflowing water from undercutting the dam as it re-enters the channel.
4. Set spacing between dams to assure that the elevation at the top of the lower dam is the same as the toe elevation of the upper dam.
5. Protect the channel downstream from the lowest check dam, since water will flow over and around the dam.
6. Make sure that the channel reach above the most-upstream dam is stable.
7. Ensure that channel appurtenances, such as culvert entrances below check dams, are not subject to damage or blockage from displaced stones.

#### 1.1.10.4 Maintenance

1. Inspect check dams and channels for damage after each runoff event until site is permanently stabilized.
2. Anticipate submergence and deposition above the check dam and erosion from high flows around the edges of the dam. Correct all damage immediately. If significant erosion occurs between dams, install a protective riprap line in that portion of the channel.
3. Remove sediment accumulated behind the dams as needed to prevent damage to channel vegetation, allow the channel to drain through the stone check dam, and prevent large flows from carrying sediment over the dam. Add stones as needed to maintain design height and cross section.

#### 1.1.11 Erosion-control blankets

##### 1.1.11.1 Description

Erosion-control blankets are biodegradable, open-weave blankets used for establishing and reinforcing vegetation on slopes, ditch bottoms and shorelines. Several categories are provided with different service application and specific uses as follows:

Category	Service application	Use	Acceptable types
1	Very Temporary	Flat areas, shoulder drain outlets, roadway shoulders, lawns, and mowed areas.	Straw, wood fiber, rapidly degradable netting on one side
2	One Season	Slopes 1:3 and steeper less than 50 ft. long, ditches with gradients 2% or less, flow velocities less than 5.0 fps.	Straw, wood fiber, netting on one side

**Table 3 Fabric categories (MPCA, 2000)**

- ✓ Category 1 is a temporary fabric used on flat areas, and around drain outlets and consists of straw and/or wood fiber with rapidly degradable netting on one side.
- ✓ Category 2 is suitable for one season use on slopes of 1:3 and steeper that are less than 50 feet long. Category 2 typically consists of straw and/or wood fiber with netting on one side.

For velocities greater than 5.0 fps alternative solutions should be examined. These include more permanent erosion control blankets and hard armor.

#### 1.1.11.2 Construction Specifications

##### *1.1.11.2.1 Site Preparation:*

- ✓ Proper site preparation is essential to ensure complete contact of the protection matting with the soil.
- ✓ Grade and shape area of installation.
- ✓ Remove all rocks, clods, and vegetative or other obstructions so that the installed blankets, or mats will have direct contact with the soil.
- ✓ Prepare seedbed by loosening 2-3 inches (50.8-76.2 mm) of topsoil above final grade.
- ✓ Incorporate amendments, such as lime and fertilizer, into soil according to soil test and the seeding plan.

##### *1.1.11.2.2 Seeding:*

- ✓ Seed area before blanket installation for erosion control and re-vegetation. Seeding after mat installation is often specified for turf reinforcement applications. When seeding prior to blanket installation, all check slots and other areas disturbed during installation must be reseeded.
- ✓ Where soil filling is specified, seed the matting and the entire disturbed area after installation and prior to filling the mat with soil.

##### *1.1.11.2.3 Anchoring:*

- ✓ U-shaped wire staples, metal geotextile stake pins, or triangular wooden stakes can be used to anchor mats to the ground surface. Wire staples should be a minimum of 11 gauge. Metal stake pins should be 3/16 inch (4.8 mm) diameter steel with a 1 1/2 inch (38.1 mm) steel washer at the head of the pin. Wire staples and metal stakes should be driven flush to the soil surface. All anchors should be 6-8 inches (0.2-0.5 m) long and have sufficient ground penetration to resist pullout. Longer anchors may be required for loose soils.

##### *1.1.11.2.4 Installation on Slopes:*

- ✓ Begin at the top of the slope and anchor blanket in a 6 inch (0.2 m) deep x 6 inch (0.2 m) wide trench. Backfill trench and tamp earth firmly.
- ✓ Unroll blanket downslope in the direction of the water flow.
- ✓ The edges of adjacent parallel rolls must be overlapped 2-3 inches (51-76 mm) and be stapled every 3 feet (0.9 m).
- ✓ When blankets must be spliced, place blankets end over end (shingle style) with 6 inch (0.2 m) overlap. Staple through overlapped area, approximately 12 inches (0.3 m) apart.
- ✓ Lay blankets loosely and maintain direct contact with the soil - do not stretch.
- ✓ Blankets shall be stapled sufficiently to anchor blanket and maintain contact with the soil. Staples shall be placed down the center and staggered with the staples placed along the edges. Steep slopes, 1:1 to 2:1, require 2 staples per square yard. Moderate slopes, 2:1 to 3:1, require 1-2 staples per square yard (1 staple 3' o.c.). Gentle slopes require 1 staple per square yard.

##### *1.1.11.2.5 Installation in channels:*

- ✓ Dig initial anchor trench 12 inches (0.3 m) deep and 6 inches (0.2 m) wide across the channel at the lower end of the project area.

- ✓ Excavate intermittent check slots, 6 inches (0.2 m) deep and 6 inches (0.2 m) wide across the channel at 25-30 foot (7.6-9.1 m) intervals along the channel.
- ✓ Cut longitudinal channel anchor slots 4 inches (101 mm) deep and 4 inches (101 mm) wide along each side of the installation to bury edges of matting. Whenever possible extend matting 2-3 inches (51-76 mm) above the crest of channel side slopes.
- ✓ Beginning at the downstream end and in the center of the channel, place the initial end of the first roll in the anchor trench and secure with fastening devices at 1 foot (.3 m) intervals. Note: matting will initially be upside down in anchor trench.
- ✓ In the same manner, position adjacent rolls in anchor trench, overlapping the preceding roll a minimum of 3 inches (7.6 cm).
- ✓ Secure these initial ends of mats with anchors at 1 foot (0.3 m) intervals, backfill and compact soil.
- ✓ Unroll center strip of matting upstream. Stop at next check slot or terminal anchor trench.
- ✓ Unroll adjacent mats upstream in similar fashion, maintaining a 3 inch (76 mm) overlap.
- ✓ Fold and secure all rolls of matting snugly into all transverse check slots. Lay mat in the bottom of the slot then fold back against itself. Anchor through both layers of mat at 1 inch (25.4 mm) intervals, then backfill and compact soil. Continue rolling all mat widths upstream to the next check slot or terminal anchor trench.

*1.1.11.2.6 Soil filling if specified for turf reinforcement:*

- ✓ After seeding, spread and lightly rake 1/2-3/4 inches (12.7-19.1 mm) of fine topsoil into the mat apertures to completely fill mat thickness. Use backside of rake or other flat implement.
- ✓ Spread topsoil using lightweight loader, backhoe, or other power equipment. Avoid sharp turns with equipment.
- ✓ Do not drive tracked or heavy equipment over mat.
- ✓ Avoid any traffic over matting if loose or wet soil conditions exist.
- ✓ Use shovels, rakes or brooms for fine grading and touch up.
- ✓ Smooth out soil filling, just exposing top netting of matrix.

*1.1.11.2.7 Inspection and maintenance:*

- ✓ All blanket and mats should be inspected periodically following installation.
- ✓ Inspect installation after significant rainstorms to check for erosion and undermining. Any failure should be repaired immediately.
- ✓ If washout or breakage occurs, re-install the material after repairing the damage to the slope or drainageway.

**1.2 Design Requirements for Stormwater Retention/Detention Ponds and Temporary Sediment Basins**

**1.2.12 General Criteria**

- ✓ Maximize distance between inlet and outlet. The goal should be to have a pond that is at least three times as long as it is wide or greater. If possible, baffles and curved flow paths should be used to prevent short-circuiting and to increase settling capacity. Walker (1990), in documentation for his P8 model, also indicates that there is evidence that vegetation in a pond or wetland may provide increased settling effectiveness by laminar settling. Vegetated benches that are perpendicular to the preferential flow path are desired over structural mechanisms.

- ✓ 1.5% to 3.5% of the drainage area should be dedicated to pond surface area – less for open areas more for paved areas.

Land Use	Percent of Watershed
Totally paved areas	3.0
Freeways	2.8
Industrial areas	2.0
Commercial areas	1.7
Institutional areas	1.7
Construction sites	1.5
Residential areas	0.8
Open spaces	0.6

**Table 4 Wet pond surface area required as a percent of drainage area, for a given land use goal of 90% sediment removal (Pitt, 1998)**

- ✓ If the dead storage volume is designed to incorporate the water quality treatment volume, that means that the design does not rely on treatment by extended detention above the outlet. The dead storage volume provides sediment storage, flow diffusion in addition to settling. Therefore, the volume below the outlet needs to exceed the water quality volume (0.3 year event) to provide equivalent treatment. The dead storage volume, adapted from the Walker pond design (Walker, 1987b), is recommended to be equal or greater than the instant runoff volume from an event twice the water quality event (2.5 inches).

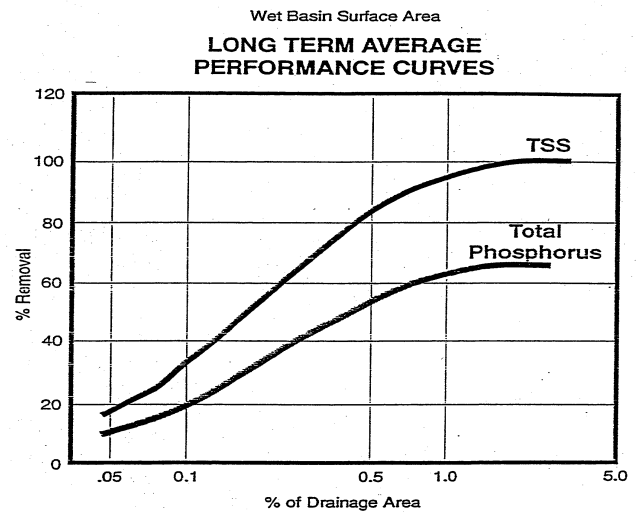

**Figure 7 Long term average pond performance based on wet basin surface area in relation to percent of drainage area (Pitt, 1998)**

- ✓ Pond design should allow for three zones. The desired pond system will have an inlet area, a primary treatment area and an outlet area as in Figure 8 . Overflow or short term storage infiltration areas designed for multiple uses are encouraged. An example may include a recreation field that provides secondary storage during events exceeding 50 years or successive events that exceed the storage capacity of the primary treatment system.
  1. Inlet area – a permanent sediment storage area 3 to 8 feet deep with an area 10-20% of the total area of the pond. This is typically the area where most of the larger particles should settle out and thus will need periodic cleaning.



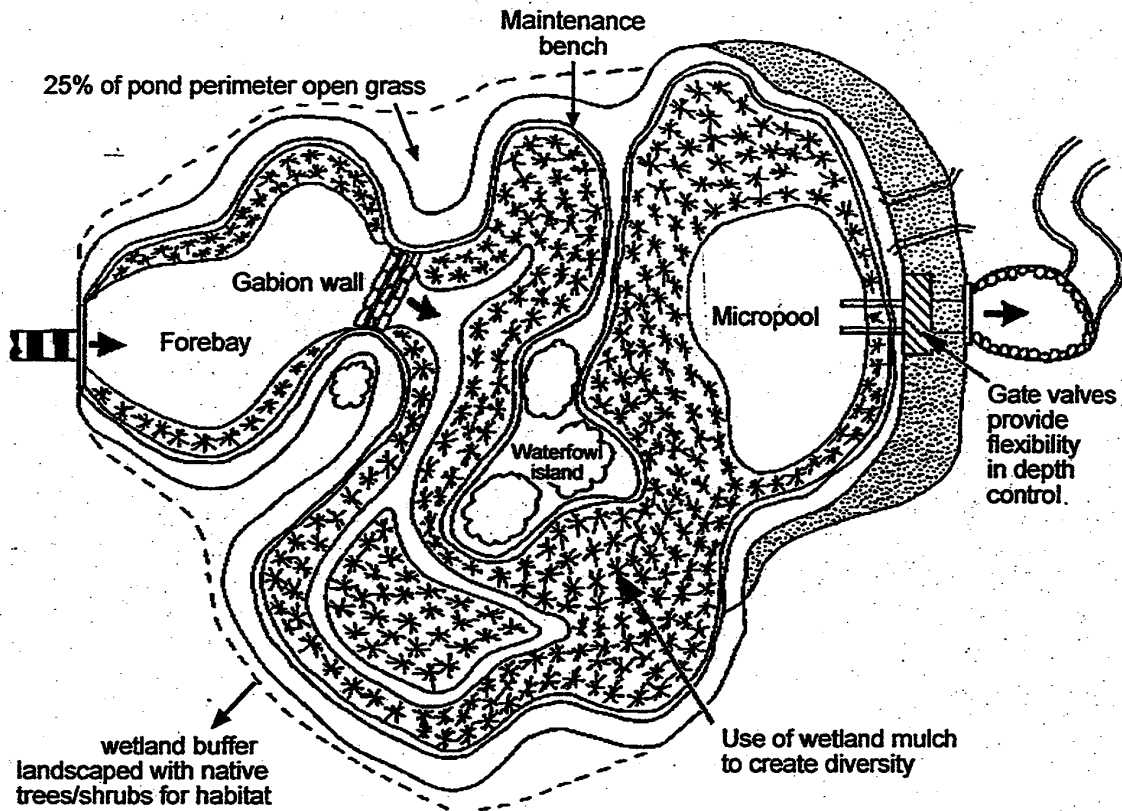

Figure 8 Baffles and contours in a pond system (Schueler, 1992)

2. Main or primary treatment area – where the velocity leaving the inlet area and entering the main treatment area should be less than 1 ft/sec.
3. The outlet area should be a deeper micropool to provide final settling and prevent resuspension of sediments. Pitt (1994a and April 29-30, 1998) found that a ratio of 5.66cfs of outflow for each acre of pond surface area resulted in a predicted sediment trapping efficiency of approximately 90%.

#### 1.2.13 Specific Requirements:

- ✓ 2, 10, and 100 year events should have peak discharge rates less than the predevelopment discharge.
- ✓ Ponds should have an access area and draw down capability for maintenance purposes.
- ✓ The average depth of the basin's permanent volume must be equal to or greater than 3 feet, with no depth greater than 10 feet.
- ✓ The basin's water quality volume is calculated as ½ inch of runoff from the new impervious surfaces created by the project.
- ✓ Basin outlets must provide a stabilized discharge point to accommodate storm events in excess of the basin's water quality volume design.

- ✓ Basin outlets must be designed to prevent short-circuiting and the discharge of floating debris. Basin outlets must have energy dissipation.
- ✓ Adequate maintenance access must be provided (typically 8ft. wide) for future maintenance of the basin.

#### 1.2.14 Temporary sediment basin

A temporary sediment basin is a controlled stormwater release structure, formed by constructing an embankment of compacted soil across a drainageway and installing an outlet structure and outlet pipe. The purpose of the basin is to detain the sediment-laden runoff from disturbed areas long enough for the majority of the sediment to settle out in the basin.

##### 1.2.14.1 General Requirements (MPCA,2003)

For common drainage locations that serve ten (10) or more acres disturbed at one time, a temporary (or permanent) sediment basin must be provided prior to the runoff leaving the construction site or entering surface waters. In addition to this requirement, the Permittee(s) is encouraged to install temporary sediment basins where appropriate in areas with steep slopes or highly erodible soils even if less than 10 acres drains to one area. The basins must be designed and constructed according to the following requirements:

1. The basins must provide storage below the outlet pipe for a calculated volume of runoff from a 2 year, 24 hour storm from each acre drained to the basin, except that in no case shall the basin provide less than 1800 cubic feet of storage below the outlet pipe from each acre drained to the basin.
2. Where no such calculation has been performed, a temporary (or permanent) sediment basin providing 3,600 cubic feet of storage below the outlet pipe per acre drained to the basin, shall be provided where attainable until final stabilization of the site.
3. Temporary basin outlets must be designed to prevent short-circuiting and the discharge of floating debris. The basin must be designed with the ability to allow complete basin drawdown (e.g., perforated riser pipe wrapped with filter fabric and covered with crushed gravel, pumps or other means) for maintenance activities, and provide a stabilized emergency overflow to prevent failure of pond integrity. Energy dissipation must be provided for the basin outlet.
4. The temporary (or permanent) basins must be constructed and made operational concurrent with the start of soil disturbance that is upgradient of the area and contributes runoff to the pond.
5. Where the temporary sediment basin is not attainable due to site limitations, equivalent sediment controls such as smaller sediment basins, and/or sediment traps, silt fences, vegetative buffer strips, or any appropriate combination of measures are required for all down slope boundaries of the construction area and for those side slope boundaries deemed appropriate as dictated by individual site conditions. In determining whether installing a sediment basin is attainable, the Permittee(s) must consider public safety and may consider factors such as site soils, slope, and available area on the site. This determination must be documented in the SWPPP.

##### 1.2.14.2 Construction Specifications:

- ✓ Construct the basin by excavating or building an embankment before any clearing or grading work begins.
- ✓ Areas under the embankment and any structural works shall be cleared, grubbed and stripped of any vegetation and rootmat as shown on the erosion and sediment control plan.

- ✓ In order to facilitate cleanout and restoration, the basin area shall be cleared, grubbed and stripped of any vegetation.
- ✓ A cut-off trench shall be excavated along the centerline of the earth fill embankments. The minimum depth shall be 2 feet (0.6 m). The cut-off trench shall extend up both abutments to the riser crest elevation.
- ✓ Fill material for the embankment should be clean mineral soil free of roots, woody vegetation, oversized stones, rocks or other objectionable material.
- ✓ The fill material shall contain sufficient moisture so that it can be formed by hand into a ball without crumbling.
- ✓ Fill material shall be placed in 6 inch (0.2 m) lifts, continuous layers over the entire length of the fill. Compacting shall be obtained by routing the hauling equipment over the fill so that the entire surface of each layer of the fill is traversed by at least one wheel or tread track of the equipment, or by the use of a compactor.
- ✓ The embankment should be constructed to an elevation of 10 percent higher than the design height to allow for settlement if compacting is achieved with hauling equipment. If compactors are used for compacting, the overbuild may be reduced to not less than 5 percent.
- ✓ The principle spillway riser shall be securely attached to the discharge. All connections shall be watertight.
- ✓ The pipe and riser shall be placed on a firm, smooth soil foundation. The connection between the riser and the riser base shall be watertight. Pervious materials such as sand, gravel or crushed stone shall not be used as backfill around the pipe or anti-seep collars without filter fabric protection.
- ✓ The fill material around the pipe spillway shall be placed in 4-inch (101 mm) layers and compacted under the shoulders and around the pipe to at least the same density as the adjacent embankment. A minimum of 2 feet (0.6 m) of compacted backfill shall be placed over the pipe spillway before crossing it with construction equipment.
- ✓ Steel base plates shall have at least 2 1/2 feet (0.8 m) of compacted earth, stone or gravel over them to prevent flotation.
- ✓ The emergency spillway shall not be installed in fill without erosion protection. Elevations, design width, and entrance and exit channel slopes are critical to the successful operation of the emergency spillway.
- ✓ Baffles shall be constructed of 4 inch (101 mm) by 4 inch (101 mm) posts and of 4 foot (1.2 m) by 8 foot (2.4 m) - 1/2inch (12.7 mm) exterior plywood. The posts shall be set at least 3 feet (0.9 m) into the ground, no further apart than 8 feet (2.4 m) center to center, and shall reach a height 6 inches (.2 m) below the riser crest elevation.
- ✓ The embankment and emergency spillway shall be stabilized with vegetation immediately following construction.
- ✓ Construction operations shall be carried out in such a manner that erosion and water pollution will be minimized.
- ✓ Tribal requirements shall be met concerning fencing and signs warning the public of hazards of soft sediment and floodwater.

#### *1.2.14.2.1 Inspection and Maintenance*

- ✓ Inspect weekly and after ¼ inch each rain.
- ✓ All damages caused by soil erosion or construction equipment shall be repaired before the end of each working day.

- ✓ Remove sediment when the sediment storage zone is half full. This sediment shall be placed in such a manner that it will not erode from the site. The sediment shall not be deposited downstream from the embankment in or adjacent to a stream or floodplain.
- ✓ When temporary structures have served their intended purpose and the contributing drainage area has been properly stabilized, the embankment and resulting sediment deposit shall be leveled or otherwise disposed of in accordance with the approved erosion and sediment control plan.

#### 1.2.15 Infiltration/infiltration areas (MPCA, 2003)

Infiltration/filtration options include but are not limited to: infiltration basins, infiltration trenches, rainwater gardens, sand filters, organic filters, bioretention areas, enhanced swales, dry storage ponds with underdrain discharge, off-line retention areas and natural depressions. Infiltration must be used only as appropriate to the site and land uses. Settleable solids, floating materials, oils and grease should be removed from the runoff to the maximum extent practicable before runoff enters the infiltration/filtration system. The Permittee(s) must evaluate the impact of constructing an infiltration practice on existing hydrologic features (e.g. existing wetlands) and try to maintain pre-existing conditions (e.g. do not breach a perched water table supporting a wetland). For a discussion of ground water warnings, design measures, maintenance considerations or other retention, detention, and treatment devices, see the MPCA's Protecting Water Quality in Urban Areas found on the MPCA's web-site.

- a) Infiltration systems should not be excavated to the final grade until the contributing drainage area has been constructed and fully stabilized.
- b) During construction of an infiltration system, rigorous sediment and erosion controls (e.g., diversion berms) should be used to keep sediment and runoff completely away from the infiltration area. The area must be staked off and marked to that heavy construction equipment will not compact the soil in the proposed infiltration area.
- c) To prevent clogging of the infiltration or filtration system, a pretreatment device such as a vegetated filter strip, small sedimentation basin, or water quality inlet (e.g., grit chamber) must be used to settle particulates before the storm water discharges in the infiltration or filtration practice.
- d) Infiltration or filtration systems shall be sufficient to infiltrate or filter a water quality volume of ½ inch of runoff from the impervious surfaces created by the project.
- e) The water quality volume shall discharge through the soil or filter media in 48 hours or less. Additional flows that cannot be infiltrated or filtered in 48 hours should be routed to bypass the system through a stabilized discharge point. A method must be provided to verify that the system is operating as designed.
- f) Appropriate on-site testing shall be conducted to ensure a minimum of 3 feet of separation from the seasonally saturated soils (or from bedrock) and the bottom of the proposed infiltration practice. Calculations and/or computer model results that demonstrate the design adequacy of the infiltration system must be included as part of the SWPPP.
- g) Adequate maintenance access must be provided (typically 8 ft. wide) along with a maintenance plan identifying whom will be performing future maintenance of the infiltration or filtration system.
- h) Use of designed infiltration systems from industrial areas with exposed significant materials or from vehicle fueling and maintenance area is prohibited.

### 1.2.16 Regional Ponds

Regional ponds can be used provided that they are constructed ponds, not a natural wetland or waterbody, (wetlands used as regional ponds must be mitigated for) and designed in accordance with this permit's design requirements for all water from impervious surfaces that reach the pond. Permittee(s) shall not construct regional ponds in wetlands, regardless of their condition, quality or designation by local plans, unless the appropriate mitigative sequence has been completed. Regional ponds cannot be used in place of temporary sediment basins. There must not be significant degradation of the waterways between the project and the regional pond. The owner must obtain written authorization from the applicable local government unit (LGU) or private entity that owns and maintains the regional pond. The LGU's or private entity's written authorization must identify that the regional pond will discharge the water quality volume (1/2 inch of runoff from the impervious watershed area) at no more than 5.66 cfs per acre of surface area of the pond. The owner must include the LGU's or private entity's written authorization in the SWPPP. The LGU's or private entity's written authorization must be obtained before the owner finalizes the SWPPP and before any application for this permit is made to the MPCA.

### 1.2.17 Combination of Practices

A combination of practices may be used such that the water quality volume of 1/2 inch of runoff from the new impervious surfaces created by the project is accounted for in the owner's permanent storm water management system (e.g., 1/4 inch infiltrated and 1/4 inch treated through a wet sedimentation pond). If any combination of practices is used, the SWPPP must contain documentation (e.g., LGU or private entity's authorization, infiltration computer model results or calculations, etc.) identifying the volume that each practice addresses.

### 1.2.18 Alternative method

Where an alternative treatment system is proposed and demonstrated by calculation, design or other methods to be at least as effective (approximately 80% removal of total suspended solids) as the permit requirements for the water quality volume the SMSC may be able to approve the method.

Where an alternative method is proposed, the additional information required above must be submitted to the SMSC a minimum of 60 days prior to the proposed starting date of the construction activity.

### 1.3 Directed Flow Outlets

- ✓ Slow water to a maximum velocity of 4 fps before it is directed onto unprotected or turfed ground. Note erosive velocities in Table 5.

Maximum permissible mean velocities recommended for straight, aged channels on small slopes										
Material	Mean velocity, clear					Mean velocity, silty				
Fine sand, colloidal	1.50					2.50				
Sandy loam, noncolloidal	1.75					2.50				
Silt loam, noncolloidal	2.00					3.00				
Alluvial silts, noncolloidal	2.00					3.50				
Ordinary firm loam	2.50					3.50				
Volcanic ash	2.50					3.50				
Stiff clay, very colloidal	3.75					5.00				
Alluvial silts, colloidal	3.75					5.00				
Shales and hardpans	6.00					6.00				
Fine gravel	2.50					5.00				
Graded loam to cobbles, noncolloidal	3.75					5.00				
Graded silts to cobbles, colloidal	4.00					5.50				
Coarse gravel, noncolloidal	4.00					6.00				
Cobbles and shingles	5.00					5.50				
Permissible velocities in cohesive soils										
Material	Loose, fps		Fairly compact, fps		Compact, fps		Very compact, fps			
Lean clayey soils	1.2		2.5		3.4		4.4			
Clays	1.3		2.8		3.9		5.4			
Heavy clayey soils	1.5		3.0		4.1		5.8			
Sandy Clays (sand <50%)	1.7		3.2		4.3		6.0			
Correction factors for cohesive and noncohesive soils to be applied to permissible velocity										
Average depth, ft.	1	2	3	4	5	6	7	8	9	10
Correction factor	0.81	0.91	0.99	1.04	1.11	1.14	1.18	1.21	1.24	1.26

**Table 5. Maximum permissible mean velocities recommended by Fortier and Scobey\* for straight, aged channels on small slopes (\*1926 Special Committee on Irrigation, ASCE).**

### 1.4 Trash Racks

- ✓ Trash racks should be designed with the assumption that they will plug. An assumption of 50% plugged will usually provide an acceptable margin of safety in urban settings. When the watershed is wooded or crop land area, assume 75% to 90% plugged.
- ✓ Unless used in a circular fashion attempt to eliminate strictly vertical bars.
- ✓ Design the trash rack for self-cleaning.
- ✓ Design for openings between bars to be no greater than 5 ½”.
- ✓ A trash rack on an outlet of any pipe must have a trash rack on the inlet.

## 1.5 Energy Dissipaters

- ✓ Primarily used when exit velocities exceed 10fps.
- ✓ Submerged or partially submerged outlets are usually effective and inexpensive energy dissipaters. Submerged dissipaters also deter vandalism and public entry. Riprap and filter blanket are necessary.
- ✓ Cast in-place structures are necessary for high discharge velocities. These structures should be covered, have a trash rack and require riprap and filter fabric.
- ✓ Precast structures are only for small pipes and require riprap and filter blanket.

## 1.6 Riprap and Filter Material

### 1.6.18.1 Description

Riprap is heavy stone placed around inlets and outlets of pipes or within channels to provide protection against erosion. Riprap is a permanent, erosion-resistant protective layer intended to prevent soil erosion in areas of concentrated flow, turbulence or wave energy.

To prevent erosion, velocities must be reduced to allowable levels before the flow enters an unprotected area. In some cases, flow velocities may be too high for economical use of an apron. In those cases, a stilling basin may be more appropriate. The stilling basin is an excavated pool of water that is lined with riprap and used to dissipate energy from high velocity flow. An impact basin is a reinforced concrete structure that slows water velocities to an acceptable level before discharging the water to an outlet channel.

### 1.6.18.2 Design guidelines

- ✓ Under no circumstance shall riprap be placed without filter blanket. For the purpose of riprap application, filter fabric means nonwoven geotextile filter fabric. Filter fabric should meet the requirements from MnDOT Type III or IV geotextile per MnDOT standard Specifications 3733.
- ✓ Discharge leaving the riprap section should be 4 fps or less.
- ✓ Riprap should be of appropriate size for the situation.

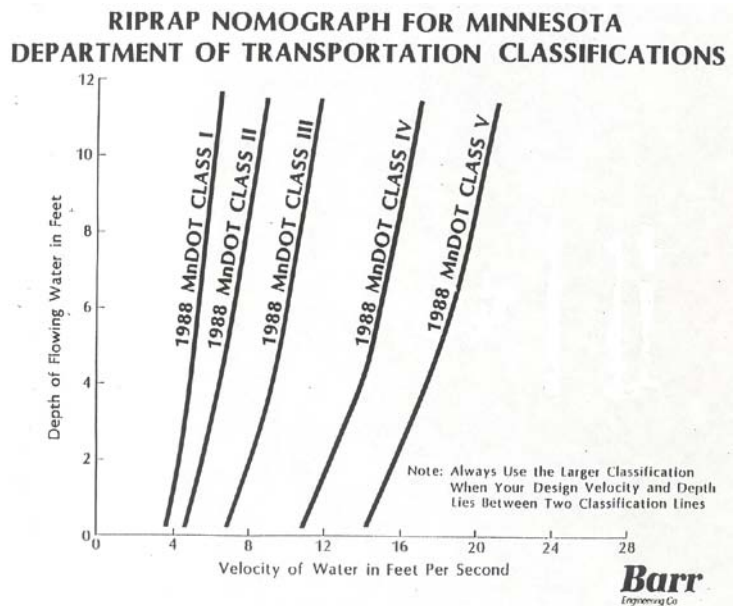

Figure 9. Riprap nomograph for Minnesota.

### 1.6.18.2.1 Construction Specifications:

- ✓ Before laying riprap and filler, prepare the subgrade to the required lines and grades shown on the plans. Compact any fill required in the subgrade to a density approximating that of the surrounding undisturbed material.
- ✓ Overfill depressions with riprap.
- ✓ Remove brush, trees, stumps, and other objectionable material.
- ✓ Cut the subgrade sufficiently deep so that the finished grade of the riprap will be at the elevation of the surrounding area. Channels should be excavated sufficiently to

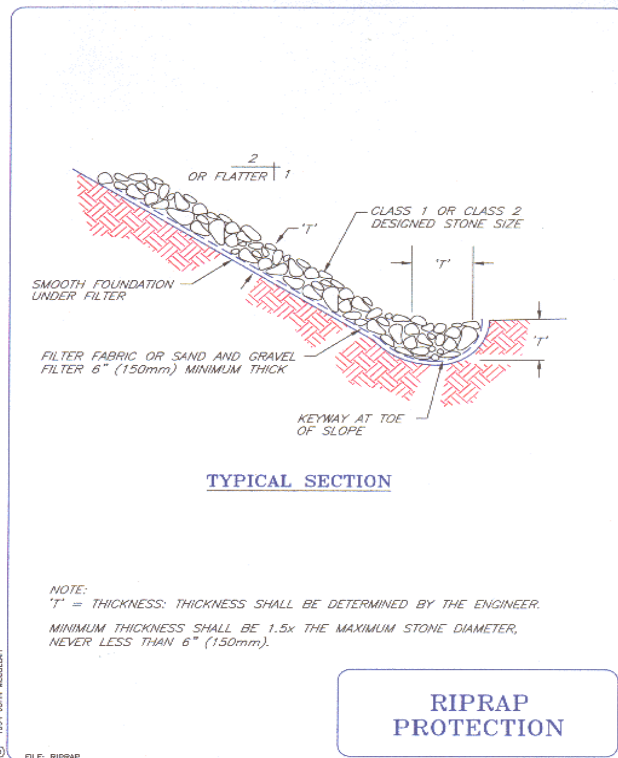

Figure 10. Riprap typical

- allow placement of the riprap in a manner such that the finished inside dimensions and grade of the riprap meet design specifications.
- ✓ Place the filter fabric directly on the prepared foundation in the direction of flow. Filter overlap of 18 to 36 inches is recommended. Space anchor pins every 3 feet (0.9 m) along the overlap. Bury the upper and lower ends of the cloth a minimum of 12 inches (0.3 m) below ground. Take care not to damage the cloth when placing riprap. If damage occurs remove the riprap and repair the sheet by adding another layer of filter material with a minimum overlap of 12 inches (0.3 m) around the damaged area. If extensive damage is suspected, remove and replace the entire sheet.
- ✓ Where large stones are used or machine placement is difficult, a 4 inch (101 mm) layer of fine gravel or sand may be needed to protect the filter fabric.
- ✓ Placement of riprap should follow immediately after placement of the filter. Place riprap so that it forms a dense, well-graded mass of stone with a minimum of voids.
- ✓ Place riprap to its full thickness in one operation.
- ✓ Do not place riprap by dumping through chutes or other methods that cause segregation of stone sizes.
- ✓ Take care not to dislodge the underlying base or filter when placing the stones.
- ✓ The toe of the riprap slope should be keyed to a stable foundation at its base.
- ✓ The toe should be excavated to the depth about 1.5 times the design thickness of the riprap and should extend horizontally from the slope.
- ✓ The finished slope should be free of pockets of small stone or clusters of large stones. Hand placing may be necessary to achieve the proper distribution of stone sizes to



produce a relatively smooth, uniform surface. The finished grade of riprap should be apparent.

#### 1.6.18.2.2 Inspection and Maintenance

Properly designed and installed riprap requires very little maintenance. Riprap should be inspected periodically for scour or dislodged stones. Control of weed and brush growth may be needed in some locations.

### 1.7 Impervious Surfaces

For BMPS not found in this manual contact the Land Department for design and construction Criteria.

#### 1.7.19 Street Design

##### 1.7.19.1 Description

Street design offers numerous opportunities to reduce impervious surfaces and thus decrease runoff and associated stormwater management requirements. Areas of opportunity include the siting of streets, street width and drainage design.

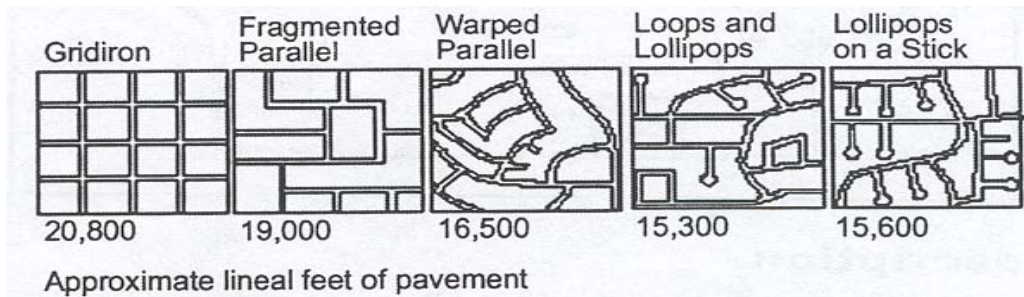

Figure 11. Street layout comparison (Source - Prince George's County, 2000 (adapted from ULI, 1980))

##### 1.7.19.2 Design

- ✓ Design residential streets with the minimum pavement width necessary to support: the traffic volume; on-street parking needs; and emergency, maintenance, and service vehicles.

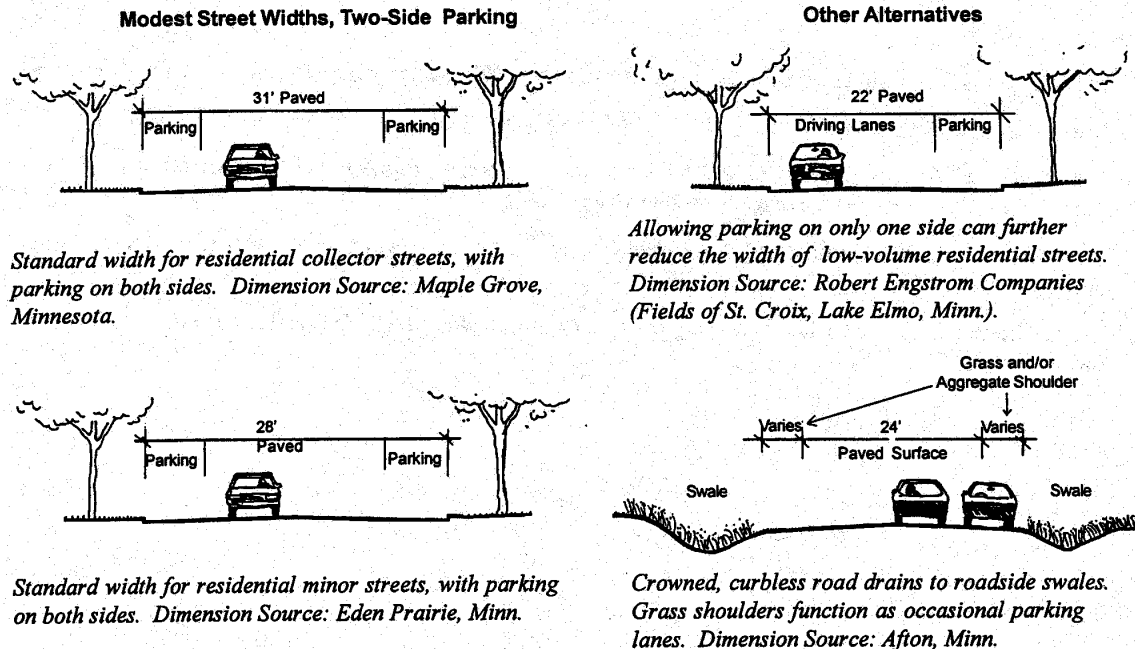

Figure 12 Street width alternatives (Source: Valley Branch Watershed District, 2000)

- ✓ Use shallow, grassed roadside swales (rural residential cross-section) instead of curb and gutter when possible (i.e. - net densities are 6 to 8 units per acre or less).
- ✓ Swales to catch road runoff should be sloped no more than 3:1.
- ✓ Limit sidewalks to one side on roads with less than 400 Average Daily Traffic (ADT) (or 200 ADT for cul-de-sacs).
- ✓ Resist designing for distant future growth.

### 1.7.20 Cul-de-Sac-Design

#### 1.7.20.1 Description

Careful cul-de-sac design can greatly reduce the amount of impervious surface in subdivisions. To do this, cul-de-sacs (also called turn-arounds or dead-ends) should use the smallest practical radius. Simply changing the radius from 40 feet to 30 feet can reduce the impervious coverage by about 50 percent (Schueler, 1995). The most common argument is that a 30 foot radius is not conducive to emergency vehicles. However, with one backing movement the largest of these vehicles can turn around.

An open depressed center with a flat apron curb will allow runoff to flow into the cul-de-sac's open center. The planted islands lessen the heat island effect, decrease development costs, lessen runoff temperature and are often seen as an amenity.

#### 1.7.20.2 Design

- ✓ Design circular cul-de-sacs with a radius of 30 feet or less whenever possible.

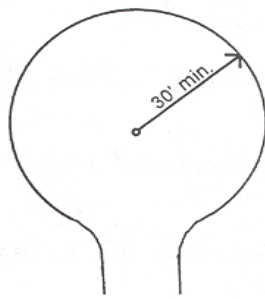

*A 30' radius will accommodate most vehicles and reduce pavement*

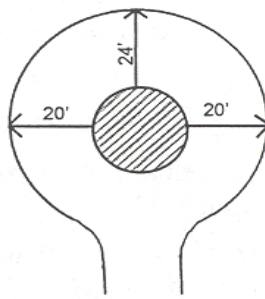

*An island can be placed to allow wider lanes in rear, making turning easier.*

- ✓ Include an unpaved, depressed island, using whatever radius will allow a 20 foot road (see Figure 13. Cul-De-Sac Design)
- ✓ To make turning easier, the pavement at the rear of the center island may be wider.
- ✓ Consider the soil moisture conditions when specifying the perennial plant species.
- ✓ A geoblock or reinforced geotextile fabric may be used to reinforce the subsurface and provide stability for larger vehicles.

**Figure 13. Cul-De-Sac Design (From Met Council 2001 - Adapted from Schueler, 1995, and ASCE, 1990**

### 1.7.21 Driveway Design

#### 1.7.21.1 Description

Driveway design is a relatively simple way to reduce stormwater runoff by limiting impervious surface. In addition, alternative grading schemes and materials can help reduce runoff

#### 1.7.21.2 Design

- ✓ For long driveways, narrow the driveway to one lane as it approaches the street.
- ✓ Use turf pavers for temporary overflow parking along driveways.
- ✓ Grade driveways to drain to pervious surfaces.
- ✓ Especially if driveway is graded to drain to yard, plant areas adjacent to driveway to help slow runoff and encourage infiltration.
- ✓ Incorporate pervious surfaces within larger driveway areas. Examples include turf islands, pervious pavers and wheel track only drive lanes.
- ✓ To ensure drainage, dry set pavers require a sand setting bed, 1 to 1-1/4 inches deep, atop a 6 to 12-inch compacted granular base (depth depends on permeability of soil) which is placed over the compacted subgrade. Lateral support may be provided by extending base beyond the pavement edge and/or by installing a rigid edge.

## 1.7.22 Parking Lot Design

### 1.7.22.1 Description

Two main strategies can help reduce runoff volume or provide water quality benefits in parking lots: reducing paved surface area and incorporating plants and infiltration swales into designs.

### 1.7.22.2 Design

- ✓ Revise outdated, overly generous parking ratio requirements (see Table 6).

Land Use	“Better Site Design” Parking Ratio
Single family home	2 spaces or less per dwelling unit (driveway spaces count)
Professional offices	3.0 spaces or less per 1,000 ft. <sup>2</sup> gross floor area
Retail	4.0 – 4.5 spaces or less per 1,000 ft. <sup>2</sup> gross floor area

**Table 6 Site design parking ratio**

- ✓ Use minimum stall dimensions.
- ✓ Use the most space-efficient stall configuration for the site.
- ✓ In larger commercial parking lots, design 30 percent of the spaces for compact cars only.
- ✓ Use pervious surfacing in summer spillover parking areas.
- ✓ If soils are suitable, drain parking lot runoff into infiltration islands using curb cuts or flat curbs.

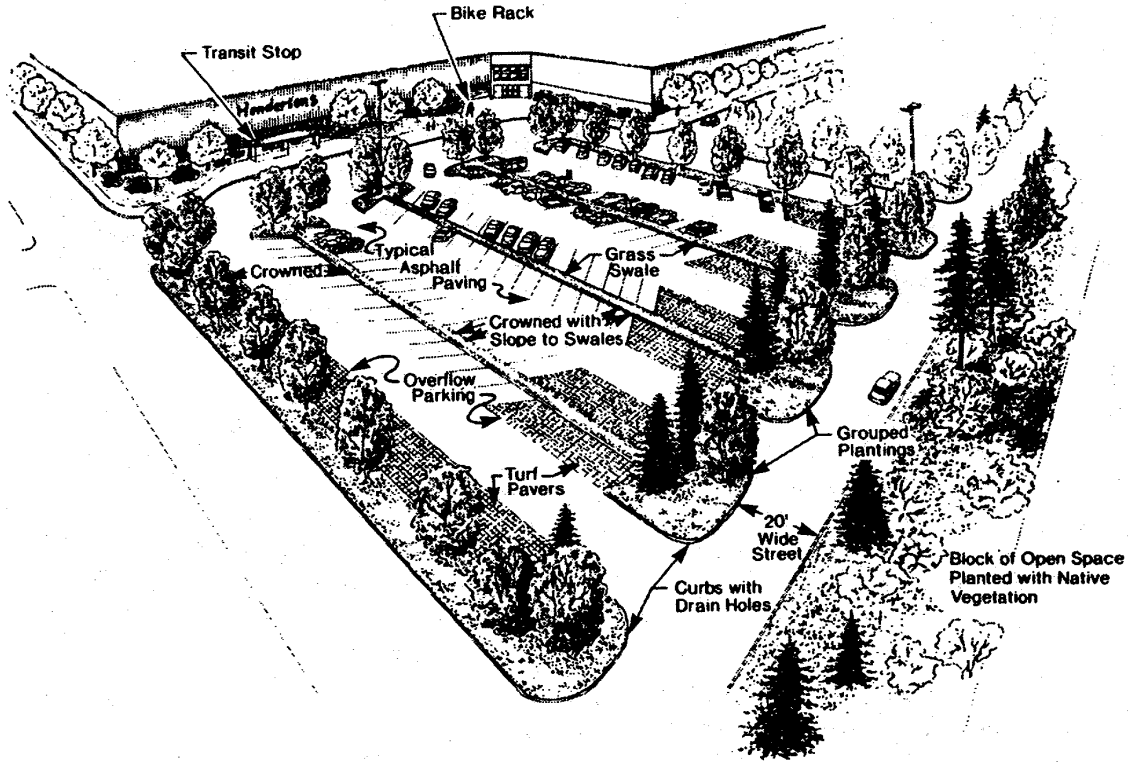

Figure 14 Alternative parking lot design (Source: Robert W. Droll, ASLA, in Wells 1994.)

- ✓ If soils are unsuitable, excavate to a depth of 3 feet and fill with a planting soil mix.
- ✓ Plant native perennials (Table 7) rather than turfgrass over as much of non-paved surfaces as possible.

<b>Mesic- Dry Soils (Sunny)</b>	
Butterfly Flower ( <i>Asclepias tuberosa</i> )	Purple Prairie Clover ( <i>Dalea purpureum</i> )
Purple Coneflower ( <i>Echinacea purpurea</i> )	Bee Balm ( <i>Monarda fistulosa</i> )
Little Bluestem ( <i>Schizachyrium scoparium</i> )	Spiderwort ( <i>Tradescantia bracteata</i> )
<b>Mesic-Dry Soils (Shady)</b>	
Wild Columbine ( <i>Aquilegia Canadensis</i> )	Wild Geranium ( <i>Geranium maculatum</i> )
Obedient Plant ( <i>Physostegia virginiana</i> )	Jacob's Ladder ( <i>Polemonium reptans</i> )
Solomon's Seal ( <i>Polygonatum biflorum</i> )	Zig Zag Goldenrod ( <i>Solidago flexicaulis</i> )
<b>Wet Soils (Sunny)</b>	
Giant Hyssop ( <i>Agastache foeniculum</i> )	Canada Anemone ( <i>Anemone canadensis</i> )
Marsh Milkweed ( <i>Asclepias incarnata</i> )	New England Aster ( <i>Aster novae-angliae</i> )
Joe-Pye Weed ( <i>Eupatorium maculatum</i> )	Obedient Plant ( <i>Physostesia virginianum</i> )
Boneset ( <i>Eupatorium perfoliatum</i> )	Queen of the prairie ( <i>Fiipendula rubra</i> )
Blueflag Iris ( <i>Iris versicolor</i> )	Great Blue Lobelia ( <i>Lobelia siphiliticia</i> )

Switchgrass ( <i>Panicum virgatum</i> )	Mountain Mint ( <i>Pycnanthemum virginianum</i> )
Tall Meadow Rue ( <i>Thalictrum dasycarpum</i> )	Culvers Root ( <i>Veronicastrum virginicum</i> )
Golden Alexander ( <i>Zizia aurea</i> )	
<b>Wet Soils (Shady)</b>	
Cardinal Flower ( <i>Lobelia cardinalis</i> )	Ostrich Fern ( <i>Matteuccia struthiopteris</i> )
Virgina Bluebells ( <i>Metensia virginica</i> )	Sensitive Fern ( <i>Onoclea sensibilis</i> )
<b>Shrubs (Sunny)</b>	
Black Chokeberry ( <i>Aronia Melanocarpa</i> )	Red-Osier Dogwood ( <i>Cornus sericia</i> )
Low Bush Honeysuckle ( <i>Diervilla ionicera</i> )	Annabelle Hydrangea ( <i>Hydrangea arborescens</i> 'Annabelle')
Pussy Willow ( <i>Salix discolor</i> )	High Bush Cranberry ( <i>Viburnum trilobum</i> )
<b>Shrubs (Shady)</b>	
Black Chokeberry ( <i>Aronia melanocarpa</i> 'alata')	Red-Osier Dogwood ( <i>Cornus sercia</i> )
Low Bush Honeysuckle ( <i>diervilla ionicera</i> )	Annabelle Hydrangea ( <i>Hydrangea arborescens</i> 'Annabelle')

**Table 7 Rainwater Gardens Plant List (Source: Fred Rozumalski, Barr Engineering)**

## 2 REFERENCES

American Society of Civil Engineers, National Association of Home Builders and Urban Land Institute. 1990. *Residential Streets*. Washington, D.C.

Minnesota Department of Transportation. 2000. *Standard Specifications for Construction*. St. Paul

Minnesota Metropolitan Council Environmental Services, Barr Engineering Company, 2001. *Minnesota Urban Small Sites BMP Manual – Stormwater Best Management Practices for Cold Climates*.

Minnesota Pollution Control Agency. 2000. *Protecting Water Quality in Urban Areas: Best Management Practices for Dealing with Storm Water Runoff from Urban, Suburban and Developing Areas of Minnesota*. St. Paul

McCullah, John. CPESC. 1994. *Erosion Draw: Erosion and Sediment Control Manual for Computer Aided Drafting*. Salix Applied EarthCare. Redding, CA.

Pitt, Robert E. 1994a. *Storm Water Detention Pond Design for Water Quality Managemetn (Draft)*. Lewis Publishers

Pitt, Robert E. April 29-30, 1998. *Course notes presented at the workshop: Storm Water Quality Management through the Use of Detention Basins*. Earl Brown Continuing Education Center, Univ. of Minnesota, St. Paul, Minn.

Prince George's County Department of Environmental Resources, Programs and Planning Division. 2000. *Low-Impact Development Design Strategies*. Largo, MD.

Rozulmalski, Fred. 2001. Plant List. Barr Engineering, Minneapolis

Schueler, Thomas R. October 1992. *Design of Storm-Water Wetland Systems: Guidelines for Creating Diverse and Effective Stormwater Wetland Systems in the Mid-Atlantic Region*. Anacostia Restoration Team, Department of Environmental Programs, Metropolitan Washington Council of Governments, Washington, D.C.

Schueler, Tom. 1995. *Site Planning for Urban Stream Protection*. Center for Watershed Protection, Silver Spring, MD.

Special Committee on Irrigation, 1926, ASCE

United States Environmental Protection Agency. 1992. *Developing Pollution Prevention Plans and Best Management Practices*. Office of Water, Washington, D.C.

Valley Branch Watershed District, 2000. *Alternative Stormwater Best Management Practices Guidebook*. Lake Elmo, MN.

Walker, W.W. 1987b. *Design Calculations for Wet Detention Ponds*. Prepared for the St. Paul Water Utility and Vadnais Lake Area Water Management Organization, St. Paul, Minn.

Wells, Cedar. 1994. "*Skinny Streets and One Sided Sidewalks: A Strategy for Not Paving Paradise*" in *Watershed Protection Techniques*, Vol 1. No 3. Center for Watershed Protection. Elliot City, MD.